

Elite Pass

Robust Facial Recognition Terminal Delegated for Entrance Barrier with Ultra-large Capacity

Compatible with
ZK BioSecurity



Elite Pass is a fast and accurate facial recognition terminal adopting deep learning algorithm that can be installed on and is compatible with entrance products such as flap barriers, swing barriers, tripod turnstiles of ZKTeco and the third parties.

With a provided pan-tilt bracket, users may adjust the direction and angle of this biometric terminal as desired to authenticate turnstile users of different height within 3 meters away from the access point, which must boost your existing security system.

Elite Pass is equipped with a 2MP starlight CMOS sensor camera with WDR function, which enables the terminal to recognize faces under extreme lighting conditions (from 0.5lux to 50,000lux), and a microwave detector which precisely detects the distance between a user and the device, then wakes the terminal to start verifying the user's identity, which certainly takes the pressure off your security team.

Apart from that, Elite Pass is powered by the latest facial recognition algorithm and ZKTeco's customized CPU for running the intellectualized engineering facial recognition algorithm. Together with the ultra-large capacity of up to 50,000 facial templates, Elite Pass offers unrivaled matching speed (less than 0.3 second per face) with strong anti-spoofing capability against almost all kinds of print and video attacks.

Features

- Ultra-large capacity: 30,000 facial templates (standard) or 50,000 facial templates (optional) for 1:N facial authentication
- Unrivalled facial recognition speed (less than 0.3 seconds per face)
- 2MP starlight CMOS sensor camera with WDR function, which enables the terminal to recognize faces under challenging lighting environment (0.5 lux – 50,000 lux)
- Anti-spoofing algorithm against print attack (laser, color and B/W photos), videos attack, and 3D mask attack
- Smart energy-saving design; a microwave detector will wake up the terminal when it precisely detects the distance between the user and the device is 3 meters (~9.84 feet) or less
- 8" touchscreen with 400 lux, which offers high visibility under strong and direct light
- Supplement lighting with adjustable brightness
- Multiple communication methods: TCP/IP
- IP68 dust-proof and waterproof standard and IK04 vandal-proof standard
- Wide range of working temperature (-30 ~ 60°C; -22 ~ 140°F)
- Compatible with different turnstiles of ZKTeco and the third parties

Specifications (Green Label Premium Feature)

Capacity

 Faces:	30,000 (standard) 50,000 (optional)
Users:	50,000
 Transactions:	1,000,000
User Photos:	20,000
Event Photos:	10,000

Compatibility

Security Relay Box
ZKBioSecurity Software



Standard Functions

Access Levels, Groups, Holidays, DST
Duress Mode, Anti-Passback
Record Query, Custom Wallpaper &
Screen Saver, Tamper Switch Alarm

Access Control Interfaces

Lock Relay Output
Alarm Output / Auxiliary Input
Exit Button / Door Sensor

Special Functions

-  IP68 & IK04
-  0.3s High Speed Facial Recognition
- Alive Body Detection
- HTTPS Encryption (optional)
- Event Snapshot



Communication

TCP / IP

Power

Operating Voltage 12V DC
Current Draw <2,000mA

Hardware

-  900MHz Dual Core Customized CPU
512MB RAM / 8G Flash
-  125KHz EM Reader / 13.56MHZ MF (optional)
2MP WDR Low Light Camera
Hi-Fi Audio
Microwave Distance Detection Sensor
-  8" High Brightness IPS Touch LCD
Reset Button & Tamper Switch

Additional Information

Face Algorithm:	ZKLiveFace 5.8
Working Temperature:	-30°C ~ 60°C (-22°F ~ 140°F)
Working Humidity:	≤93%
Storage Temperature:	-40°C ~ +65°C (-40°F ~ +149°F)
Storage Humidity:	≤93%
Net Weight:	1,706g
Dimensions (H*L*D):	343*144*94.8mm

Wiring Diagram

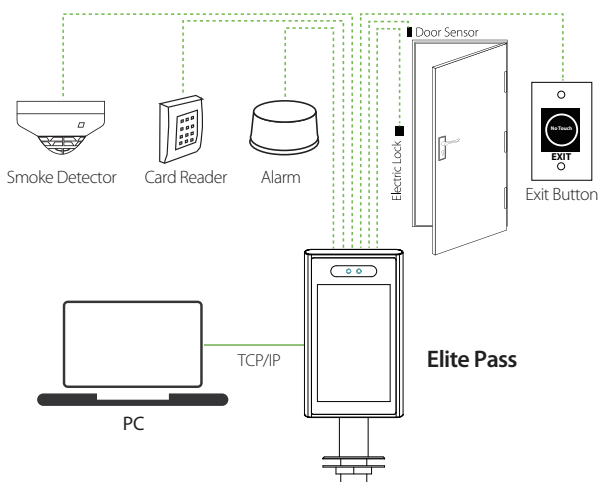

Dimensions (mm)

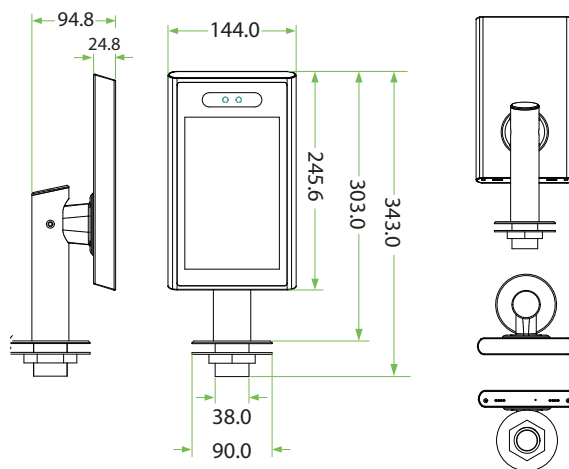

V1.0 2021.08.11